

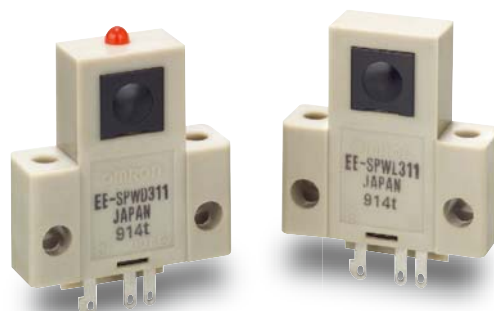

EE-SPW311/411

Through-beam Photomicrosensor with a sensing distance as long as 1 m.

- Easy operation monitoring with bright light indicator.
- Wide operating voltage range: 5 to 24 VDC
- Light modulation effectively reduces external light interference.
- Easy-to-wire connector assures ease of maintenance.





 Be sure to read *Safety Precautions* on page 3.

Ordering Information

Sensors

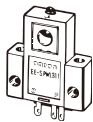
 Infrared light

Appearance	Sensing method	Sensing distance	Output type	Output configuration	Model
	Through-beam type	 1m	NPN output	Dark-ON	EE-SPW311
				Light-ON	EE-SPW411

* Both an EE-1006L Connector with Cable for the Emitter and an EE-1006D Connector with Cable for the Receiver are included with the Photomicrosensor.

Ratings and Specifications

Item	Models	EE-SPW311, EE-SPW411
Sensing distance		1 m
Sensing object		Opaque: 5 mm dia. min.
Directional angle		5 to 20°
Light source		GaAs infrared LED (pulse lighting) with a peak wavelength of 940 nm
Indicator *1		Light indicator (red)
Supply voltage		5 (-5%) to 24 (+10%) VDC, ripple (p-p): 5% max.
Current consumption		40 mA max. (Emitter: 20 mA max., Receiver: 20 mA max.)
Control output		NPN open collector: Load power supply voltage: 5 to 24 VDC Load current: 100 mA max. 100 mA load current with a residual voltage of 0.8 V max. 10 mA load current with a residual voltage of 0.4 V max.
Response frequency *2		100 Hz min.
Ambient illumination		3,000 lx max. with incandescent light on the surface of the receiver
Ambient temperature range		Operating: -10 to +55°C Storage: -25 to +65°C
Ambient humidity range		Operating: 5% to 85% Storage: 5% to 95%
Vibration resistance		Destruction: 200 to 2,000 Hz (peak acceleration: 100 m/s ²) 1.5-mm double amplitude for 2 h (4-min periods) each in X, Y, and Z directions
Shock resistance		Destruction: 500 m/s ² for 3 times each in X, Y, and Z directions
Enclosure rating		IEC IP60
Connecting method		Special connector (soldering not possible)
Weight (packaged)		Approx. 8.8 g
Material	Case	Polybutylene phthalate (PBT)
	Lens	Polycarbonate
Accessories		EE-1006L/D Connectors with Cables, Instruction Manual

*1. The indicator is a GaP red LED (peak wavelength: 700 nm).
*2. The response frequency was measured by detecting the following rotating disk.

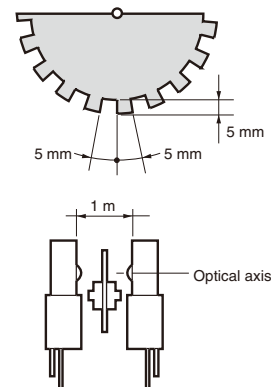

Engineering Data (Typical)

Receiver Output Excess Gain Vs. Sensing Distance Characteristics

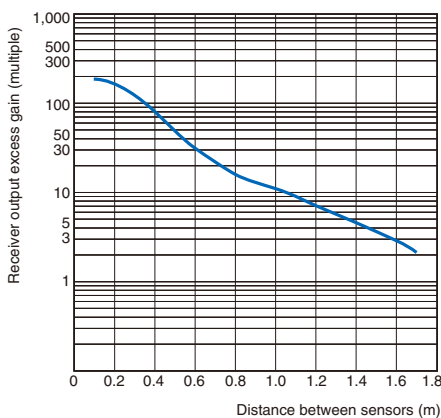

Parallel Movement Characteristics

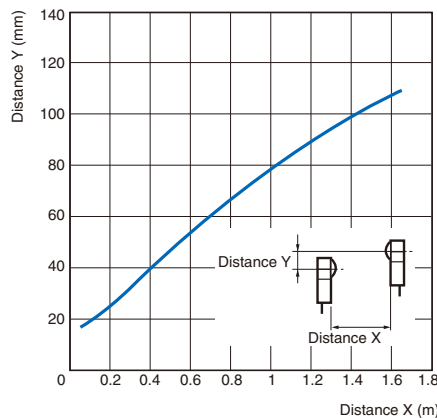

I/O Circuit Diagrams

NPN Output

Model	Output configuration	Timing charts	Output circuit
EE-SPW411	Light-ON		
EE-SPW311	Dark-ON		

Safety Precautions

Refer to *Warranty and Limitations of Liability*.

⚠ WARNING

This product is not designed or rated for ensuring safety of persons either directly or indirectly. Do not use it for such purposes.



Precautions for Correct Use

Make sure that this product is used within the rated ambient environment conditions.

● Wiring

- Connection is made using a connector. Do not solder to the pins (leads).
- When extending the cable, use an extension cable with conductors having a total cross-section area of 0.3 mm². The total cable length must be 10 m maximum.
- To use a cable length longer than 10 m, attach a capacitor with a capacitance of approximately 10 μF to the wires as shown below. The distance between the terminal and the capacitor must be within 10 m. (Use a capacitor with a dielectric strength that is at least twice the Sensor's power supply voltage.)

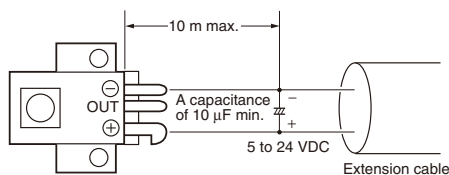

● Axis Adjustment

- (1) Tentatively mount the emitter and receiver so that the center of each lens is in a single line.

Side view

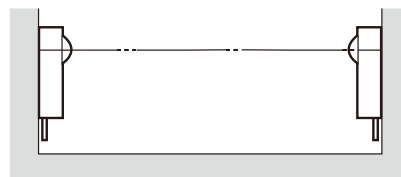

Top view



- (2) Turn ON the emitter and receiver after making sure that they have been wired correctly. When power is turned ON, the light indicator on the receiver will light. Make sure that the light indicator is OFF when an object intercepts the optical axis and that the light indicator lights again when the object is removed.

- (3) Fix the position of the receiver (or emitter) securely, move the emitter (or receiver) horizontally and vertically to check the range in which the operation indicator is lit. Then locate the emitter (or receiver) in the center of the range and fix the position securely.

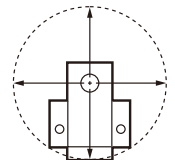

Dimensions

(Unit: mm)

Sensors

EE-SPW311
EE-SPW411

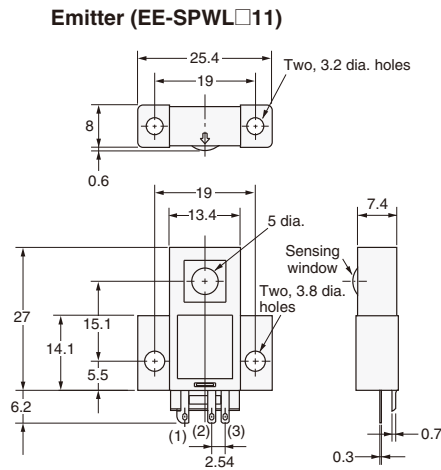
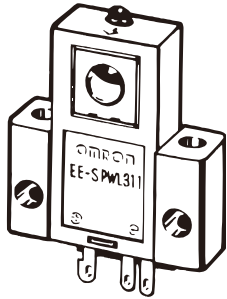

Terminal Arrangement

(1)	+	Vcc
(2)	---	Vacant
(3)	-	GND (0 V)

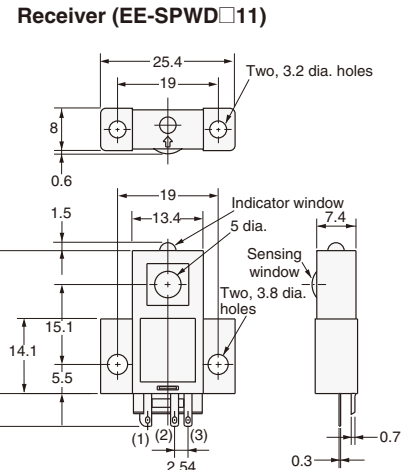

Terminal Arrangement

(1)	+	Vcc
(2)	OUT	OUTPUT
(3)	-	GND (0 V)

Accessories (Included)

Connector with Cable for Emitter

EE-1006L

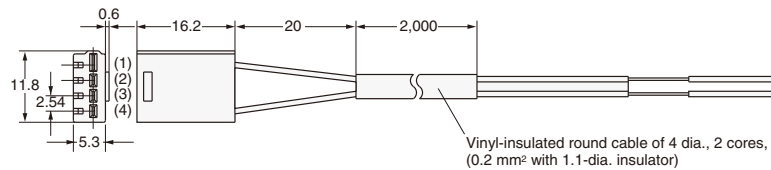
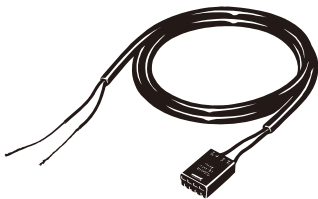

(1)	Brown	+
(4)	Blue	-

Connector with Cable for Receiver

EE-1006D

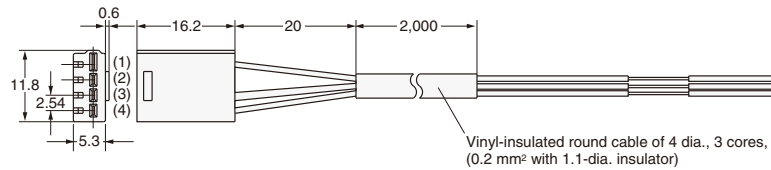
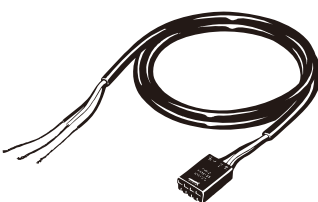

(1)	Brown	+
(3)	Black	OUT
(4)	Blue	-

Note: These cables can also be ordered separately.